

Imperial [IP] Dimensions
Metric (SI) in Parentheses

Steel Modular Core Diffuser Square Neck, Flange Frame Surface Mount

CARNES COMPANY 448 S. Main St., P. O. Box 930040, Verona, WI 53593-0040 Phone: (608)845-6411 Fax: (608)845-6504 www.carnes.com

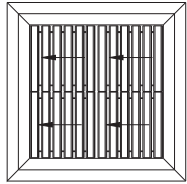

1-Way

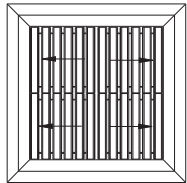

2-Way Opposite

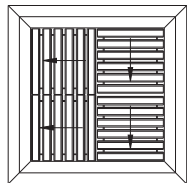

2-Way Corner

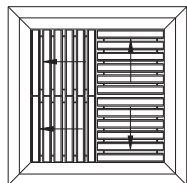

3-Way

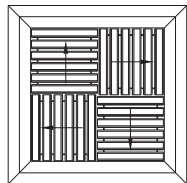

4-Way

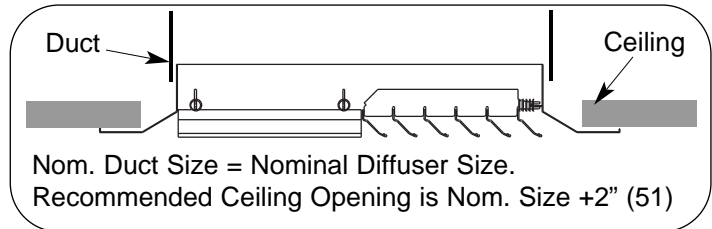
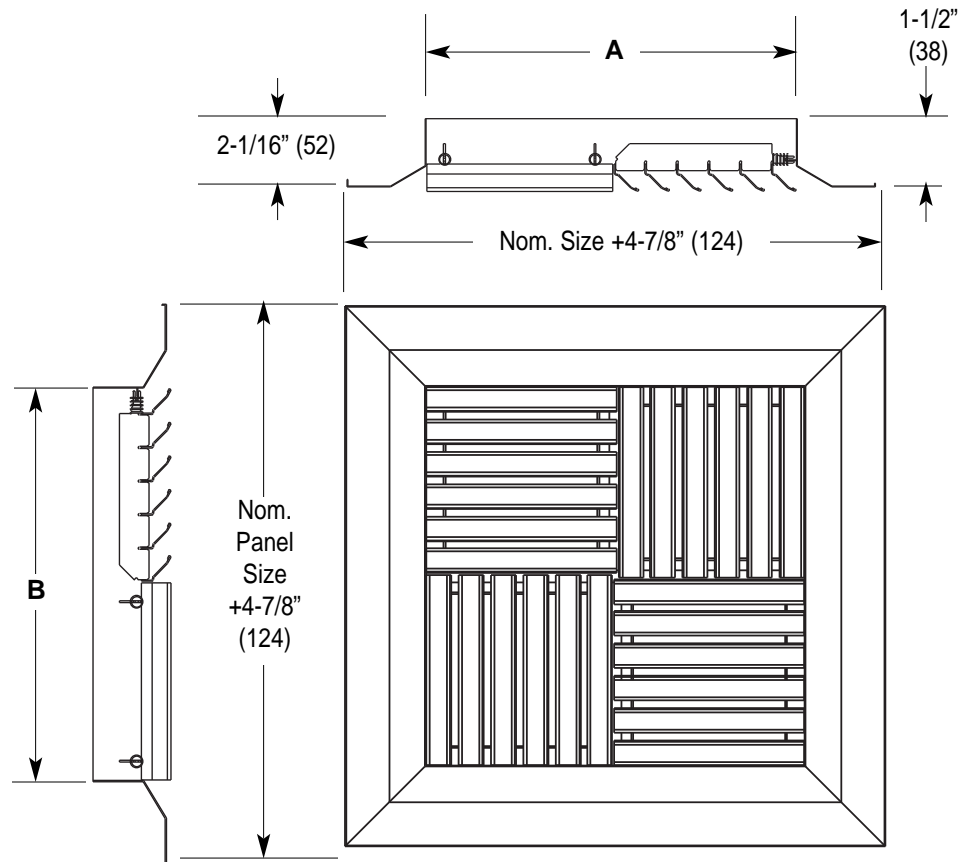

Notes:

1. Construction is steel.
2. Standard finish is electrocoat acrylic baked enamel. Other finishes are available on request.
3. Standard color is #11 Bright White. Other colors are available on request.
4. Metric dimensions are in millimeters.

| Nominal Size | Neck Outside Diameter (A x B) |
|-----------------------|-------------------------------|
| 6" x 6" (152 x 152) | 5-7/8" x 5-7/8" (149 x 149) |
| 8" x 8" (203 x 203) | 7-7/8" x 7-7/8" (200 x 200) |
| 10" x 10" (254 x 254) | 9-7/8" x 9-7/8" (251 x 251) |
| 12" x 12" (305 x 305) | 11-7/8" x 11-7/8" (302 x 302) |
| 14" x 14" (356 x 356) | 13-7/8" x 13-7/8" (352 x 352) |
| 16" x 16" (406 x 406) | 15-7/8" x 15-7/8" (403 x 403) |
| 18" x 18" (457 x 457) | 17-7/8" x 17-7/8" (454 x 454) |
| 20" x 20" (508 x 508) | 19-7/8" x 19-7/8" (505 x 505) |
| 22" x 22" (559 x 559) | 21-7/8" x 21-7/8" (556 x 556) |
| 24" x 24" (610 x 610) | 23-7/8" x 23-7/8" (607 x 607) |