

Imperial [IP] Dimensions  
Metric (SI) in Parentheses

CARNES COMPANY 448 S. Main St., P. O. Box 930040, Verona, WI 53593-0040 Phone: (608)845-6411 Fax: (608)845-6504 www.carnes.com

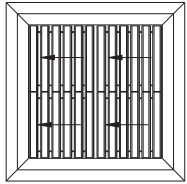

**1-Way**

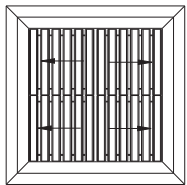

**2-Way Opposite**

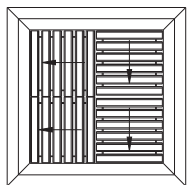

**2-Way Corner**

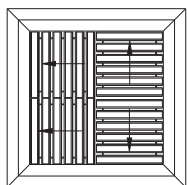

**3-Way**

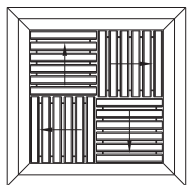

**4-Way**

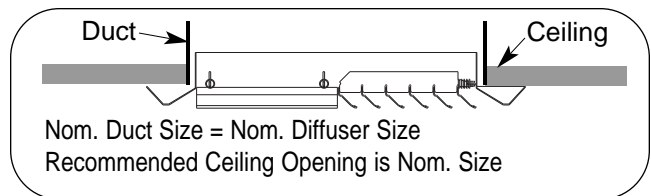
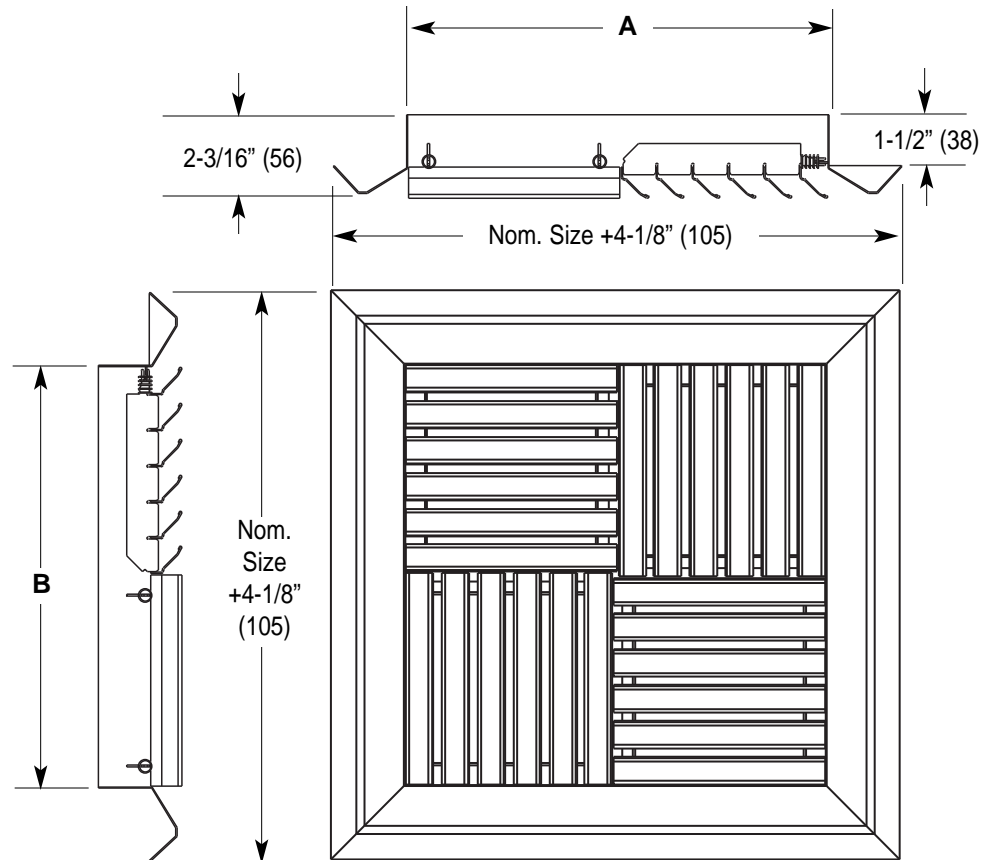

**Notes:**

1. Construction is aluminum.
2. Standard finish is electrocoat acrylic baked enamel. Other finishes are available on request.
3. Standard color is #11 Bright White. Other colors are available on request.
4. Metric dimensions are in millimeters.

Nominal Size	Neck Outside Diameter (A x B)
6" x 6" (152 x 152)	5-7/8" x 5-7/8" (149 x 149)
8" x 8" (203 x 203)	7-7/8" x 7-7/8" (200 x 200)
10" x 10" (254 x 254)	9-7/8" x 9-7/8" (251 x 251)
12" x 12" (305 x 305)	11-7/8" x 11-7/8" (302 x 302)
14" x 14" (356 x 356)	13-7/8" x 13-7/8" (352 x 352)
16" x 16" (406 x 406)	15-7/8" x 15-7/8" (403 x 403)
18" x 18" (457 x 457)	17-7/8" x 17-7/8" (454 x 454)
20" x 20" (508 x 508)	19-7/8" x 19-7/8" (505 x 505)
22" x 22" (559 x 559)	21-7/8" x 21-7/8" (556 x 556)
24" x 24" (610 x 610)	23-7/8" x 23-7/8" (607 x 607)