

EGGCRATE RETURN AIR GRILLES and REGISTERS

The all aluminum eggcrate return air grilles feature a natural anodize extruded aluminum frame and fabricated aluminum louvers (mill finish). Registers are available with either an extruded aluminum or steel opposed blade damper.

1/2" x 1/2" x 1/2" LOUVER

1" x 1" x 1" LOUVER

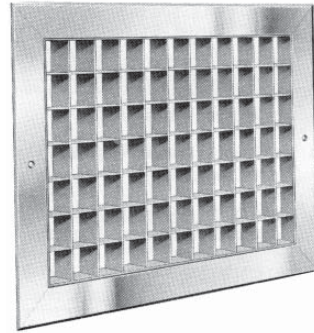
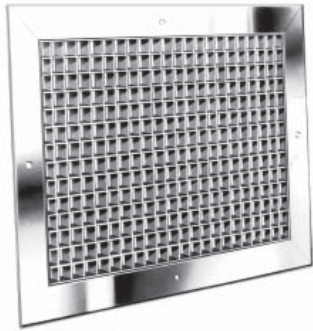

Approximately
90% Free
Area

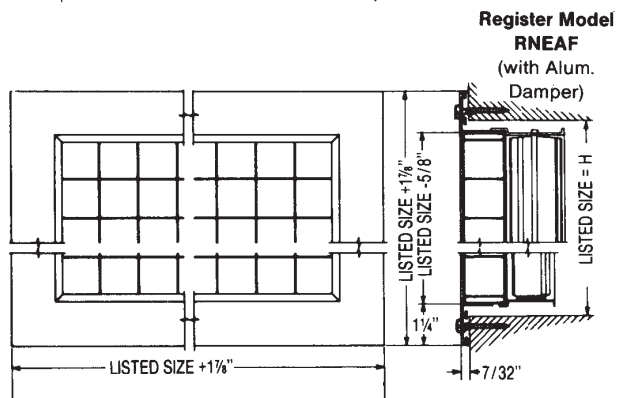
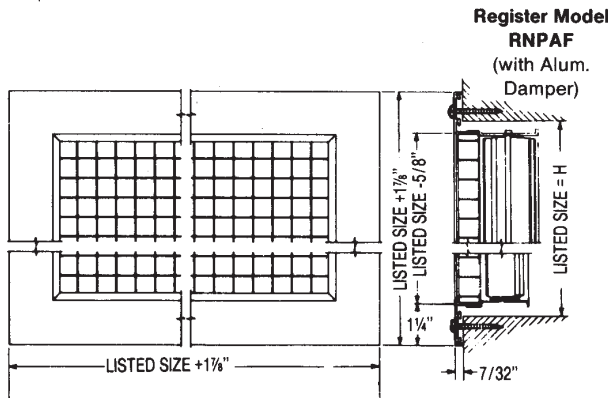
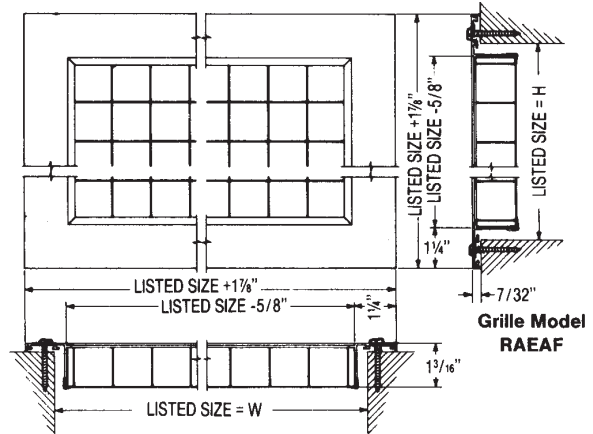
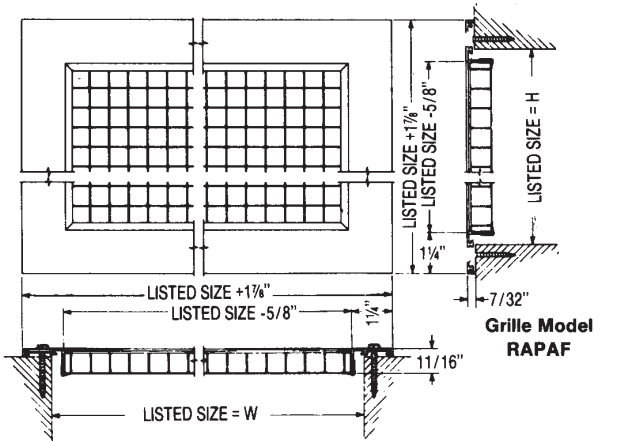

NOTES:

A. 1/2" x 1/2" x 1/2" also available.
Model RAPAC - Core ONLY
Model RAPAS - Spline Ceiling
Model RAPAH - U Channel for T-bar

B. 1" x 1" x 1" available as core ONLY.
Model RAEAC

C. 1/2" x 1/2" x 1" available in:
Model RATAF - Grille
Model RNTAF & RWTAF - Registers
Model RATAAC - Core ONLY

MODEL NUMBERING SYSTEM — Eggcrate Return Air Registers and Grilles

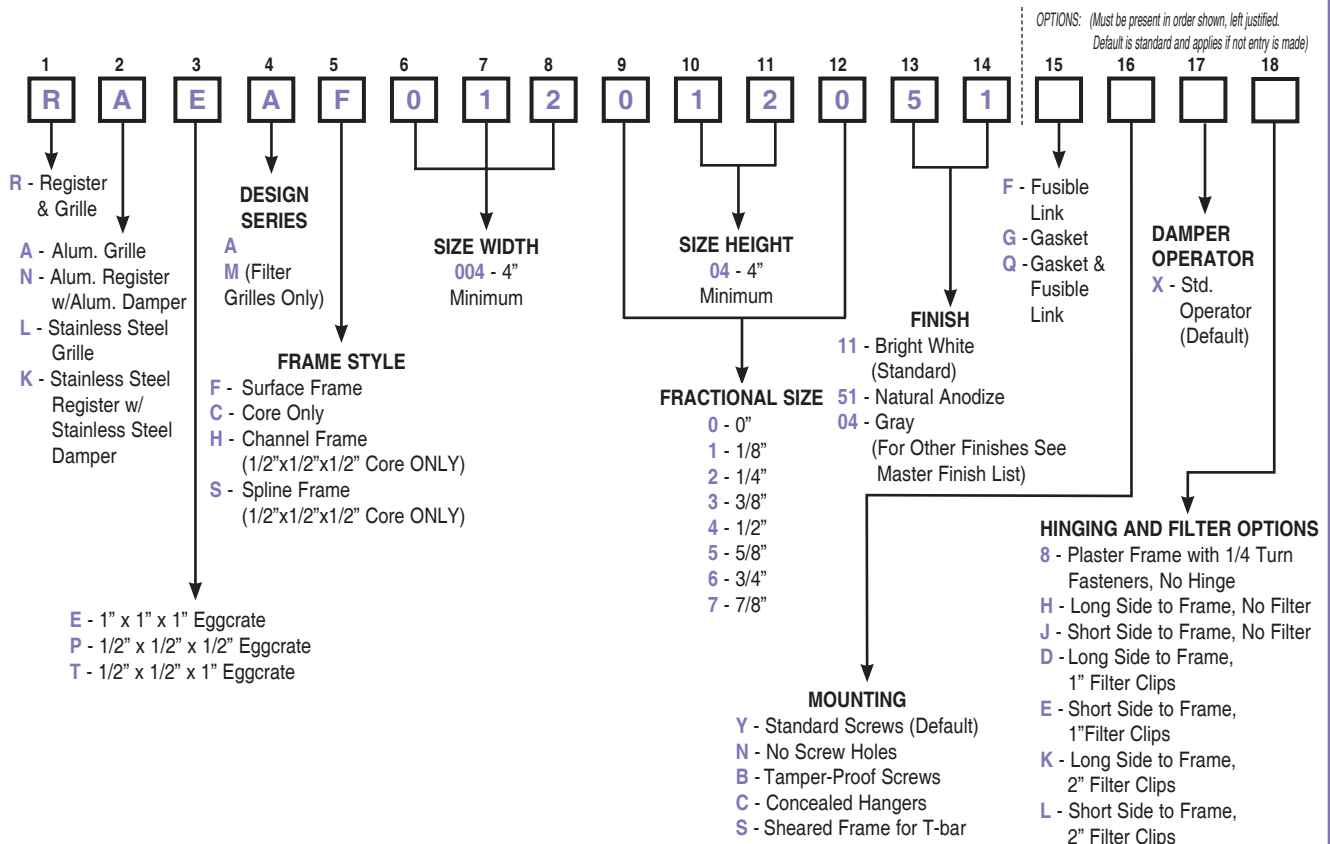

RETURN AIR PERFORMANCE DATA — Models RAEA & RAPA Eggcrate Return Air Registers and Grilles

DUCT VELOCITY	200 FPM		300 FPM		400 FPM		500 FPM		600 FPM		800 FPM		1000 FPM	
	CFM	NC	CFM	NC	CFM	NC	CFM	NC	CFM	NC	CFM	NC	CFM	NC
6 x 6	50	—	75	—	100	—	125	—	150	—	200	22	250	30
8 x 8	89	—	133	—	178	—	222	—	266	—	355	24	444	32
10 x 8	111	—	167	—	222	—	278	—	333	15	444	25	555	33
10 x 10	139	—	208	—	278	—	347	—	416	16	555	26	694	34
12 x 8	133	—	200	—	267	—	333	—	400	16	533	26	667	34
12 x 12	200	—	300	—	400	—	500	—	600	18	800	28	1000	36
14 x 10	194	—	292	—	389	—	486	—	583	18	778	28	972	36
18 x 10	250	—	375	—	500	—	625	—	750	19	1000	29	1250	37
18 x 12	300	—	450	—	600	—	750	—	900	20	1200	30	1500	38
18 x 18	450	—	675	—	900	—	1125	15	1350	21	1800	31	2250	39
24 x 12	400	—	600	—	800	—	1000	15	1200	21	1600	31	2000	39
24 x 18	600	—	900	—	1200	—	1500	17	1800	23	2400	33	3000	41
24 x 24	800	—	1200	—	1600	—	2000	18	2400	24	3200	34	4000	42
30 x 12	500	—	750	—	1000	—	1250	16	1500	22	2000	32	2500	40
36 x 12	600	—	900	—	1200	—	1500	17	1800	23	2400	33	3000	41
36 x 18	900	—	1350	—	1800	—	2250	19	2700	25	3600	35	4500	43
36 x 24	1200	—	1800	—	2400	—	3000	20	3600	26	4800	36	6000	44
36 x 36	1800	—	2700	—	3600	—	4500	22	5400	28	7200	38	9000	46
48 x 24	1600	—	2400	—	3200	—	4000	21	4800	27	6400	37	8000	45
48 x 36	2400	—	3600	—	4800	15	6000	23	7200	29	9600	39	12000	47
48 x 48	3200	—	4800	—	6400	16	8000	24	9600	30	12800	40	16000	48

Multi-Panel Construction for the following Registers & Grilles

Steel
 Louvered Return RSLA, RTLA
 Perforated Return RSFA, RTFA

In-Line Construction

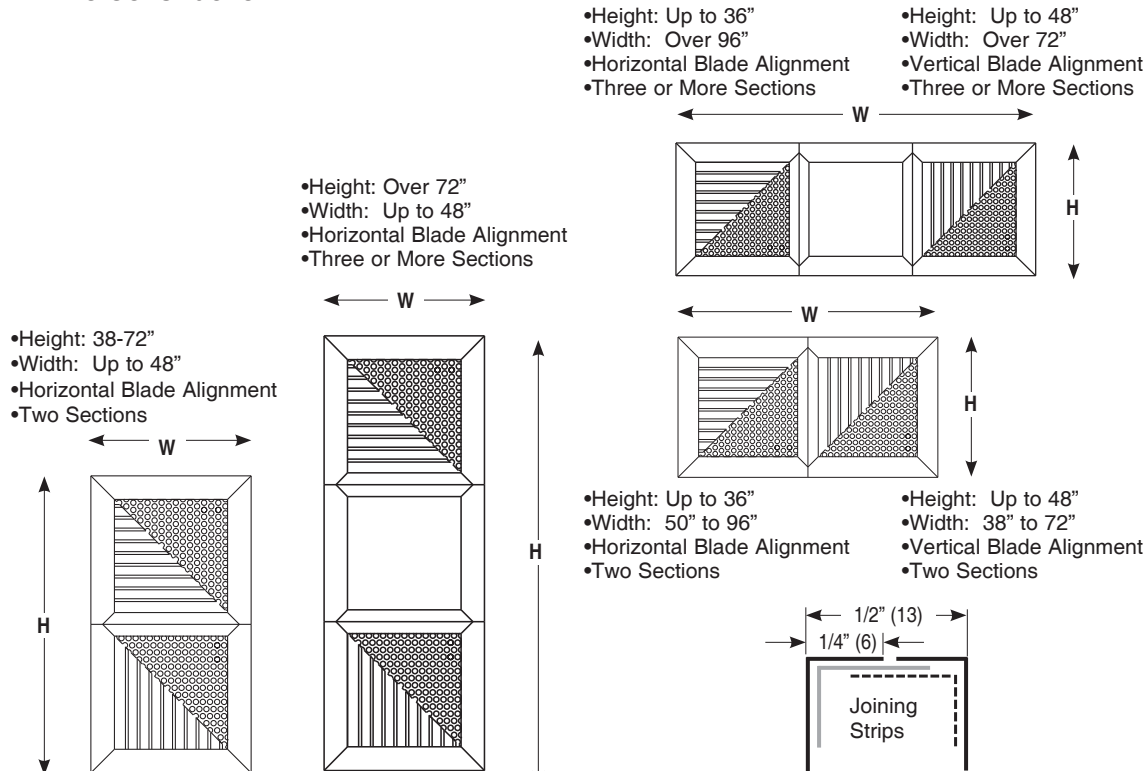

Notes:

1. Panels will be made in even inch increments unless specified otherwise.
2. Dimensions shown are listed size dimensions.
3. Max. blade length on louvered face models is nominal 48".
4. Panels are sheared and aligned with joining strips.

Ganged Construction

Notes:

1. Either the vertical or horizontal joint can be sheared down, but not both.
2. Maximum single panel width is 48" listed size.
3. Maximum blade length on louvered face models is listed size 48".
4. Maximum single panel height is 36" listed size.
5. Panels are made in even inch increments unless specified otherwise.
6. Blade alignment is always parallel to center support.
7. The center support can be aligned vertically or horizontally, depending on the blade alignment desired. It is shown here mounted horizontally.
8. Grille dimensions shown are listed size dimensions.

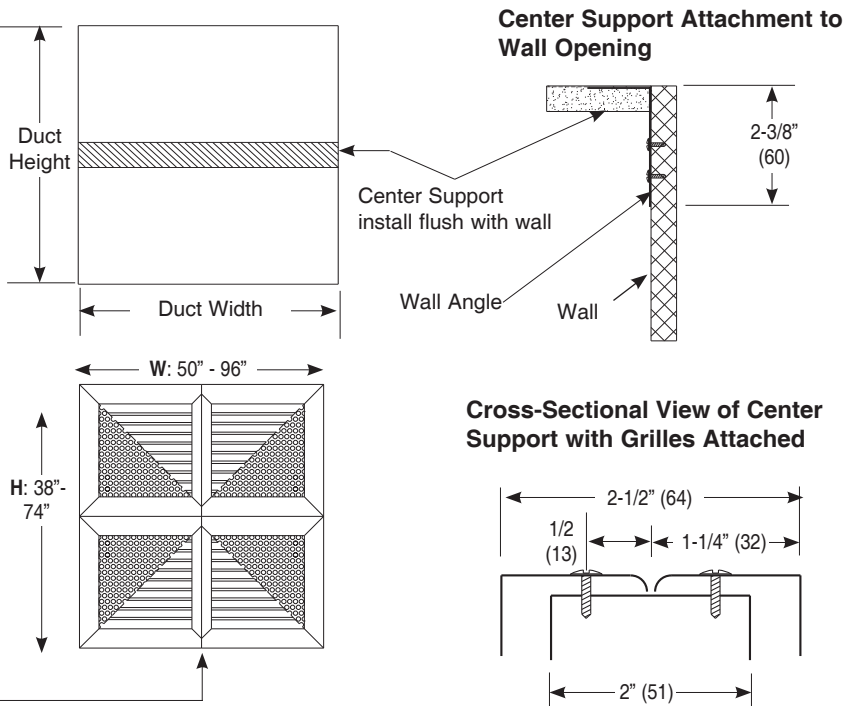
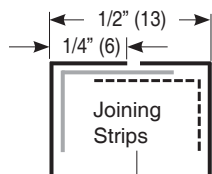

Multi-Panel In-Line Construction

Notes:

1. Maximum single panel width and height is 48" nominal size, regardless of blade alignment.
2. Panels are made in even inch increments unless specified otherwise.
3. Front blade alignment is as pictured.
4. Grille dimensions shown are nominal dimensions.
5. Panel flanges are sheared and aligned with joining strips.

- Height: 50-96"
- Width: Up to 48"
- Two Sections
- Any Blade Alignment

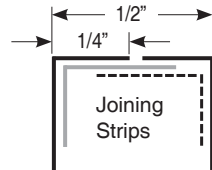
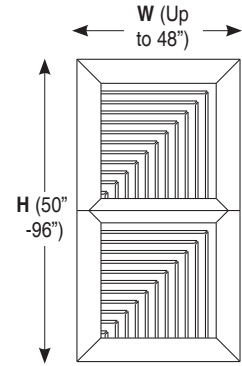

- Height: Over 96"
- Width: Up to 48"
- Three or more Sections
- Any Blade Alignment

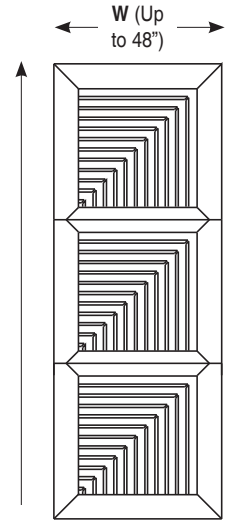

- Height: Up to 48"
- Width: 50" - 96"
- Two Sections
- Any Blade Alignment

- Height: Up to 48"
- Width: Over 96"
- Three or more Sections
- Any Blade Alignment

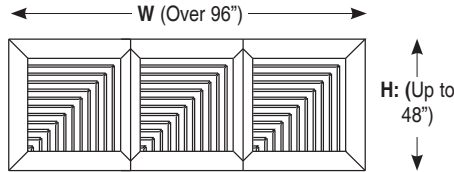
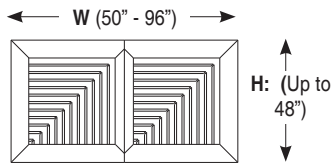

Multi-Panel Ganged Construction

Notes:

1. Maximum single panel width and height are 48" nominal size.
2. Panels are made in even inch increments unless specified otherwise.
3. Front blade alignment is always parallel to center support.
4. Either the vertical or horizontal joint can be sheared down, but not both.
5. The center support can be aligned vertically or horizontally, depending on blade alignment desired.
6. Grille dimensions shown are nominal dimensions.

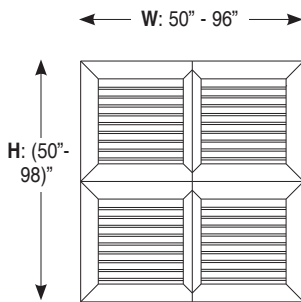

Cross-Sectional View of Center Support

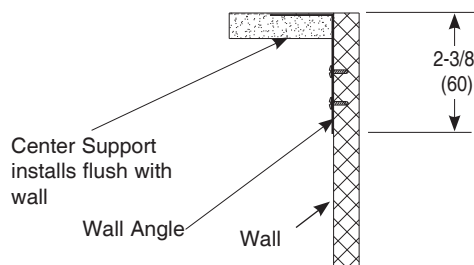
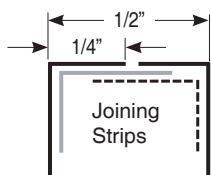
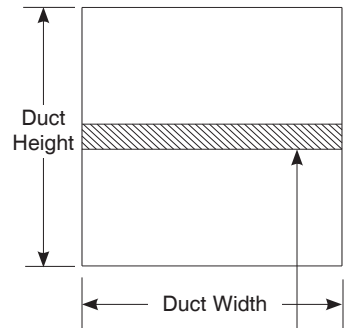
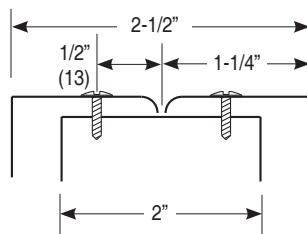

Center Support Mounted flush with wall (Shown aligned horizontally).

All Sections of Butted Grilles or Registers will be made in Listed Sizes as Standard.

STANDARD REGISTERS AND GRILLES

Applies to all models except louvered return air registers and grilles and door partition grilles.
Registers and grilles over 36" x 36" butting two or more grilles together.

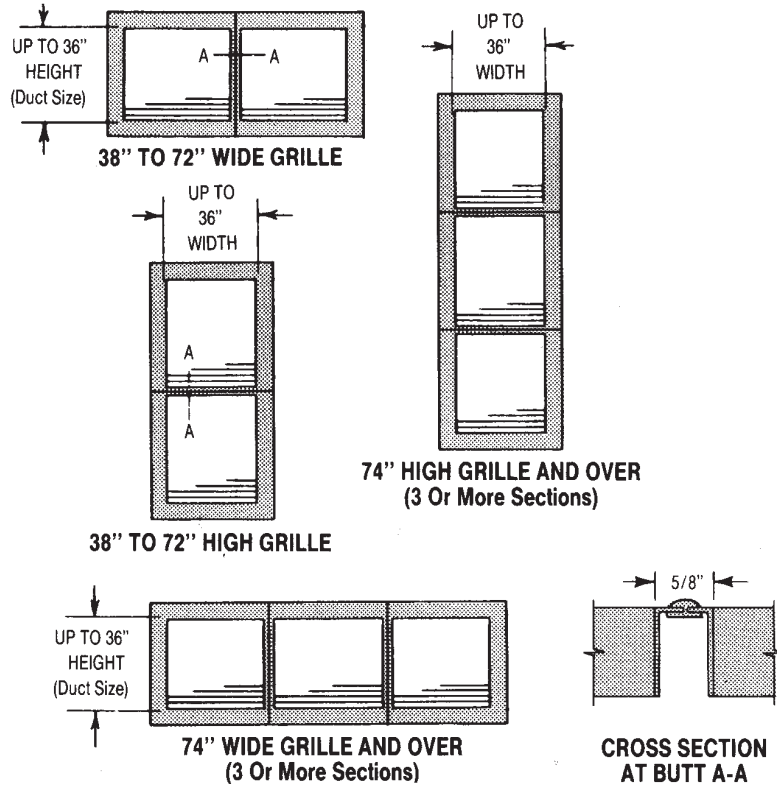

GRILLES AND REGISTERS HAVING FOUR SECTIONS AND OVER

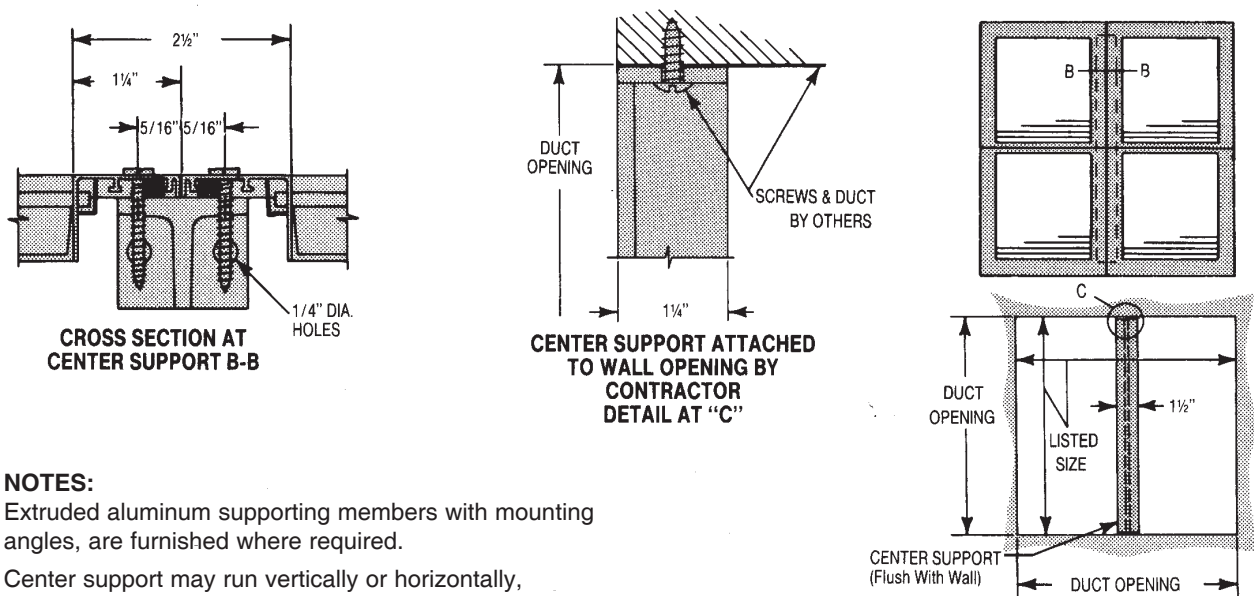

NOTES:

Extruded aluminum supporting members with mounting angles, are furnished where required.

Center support may run vertically or horizontally, depending upon combination of grilles used.

Combination of panels will be furnished to fit duct opening with satisfactory clearance.

Screw Hole Location for the following Registers & Grilles

	Steel	Aluminum	Stainless Steel
Single Deflection	RSSB, RTSB	RASM, RNSM	RLSB, RKSB
Double Deflection	RSDB, RTDB	RADM, RNDM	RLDB, RKDB
0° Fixed Return	RSRB, RTRB	RARM, RNRM	RLRB, RKRB
45° Fixed Return	RSAB, RTAB	RAAM, RNAM	RLAB, RKAB
Louvered Return	RSLA, RTLA	-----	-----
Perforated Return	RSFA, RTFA	RAFM, RNFM	-----

Notes:

- Screw holes on the face are standard on Registers and Grilles.
- Steel R&G can be ordered without screw holes, for use with concealed hangers (Opt. N).
- The screw holes is 5/32" in diameter.
- Each Register or Grille is provided with the appropriate number of screws as standard.
- The standard screw is #8 x 1-1/4" pan head screw, with a flat blade head.
- Tamper-proof screws are available as an option (Opt. B).

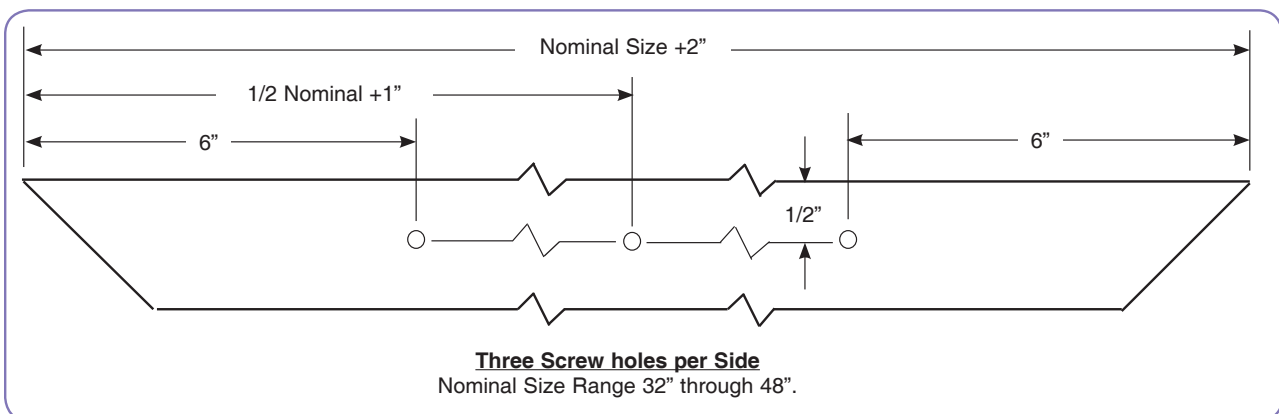
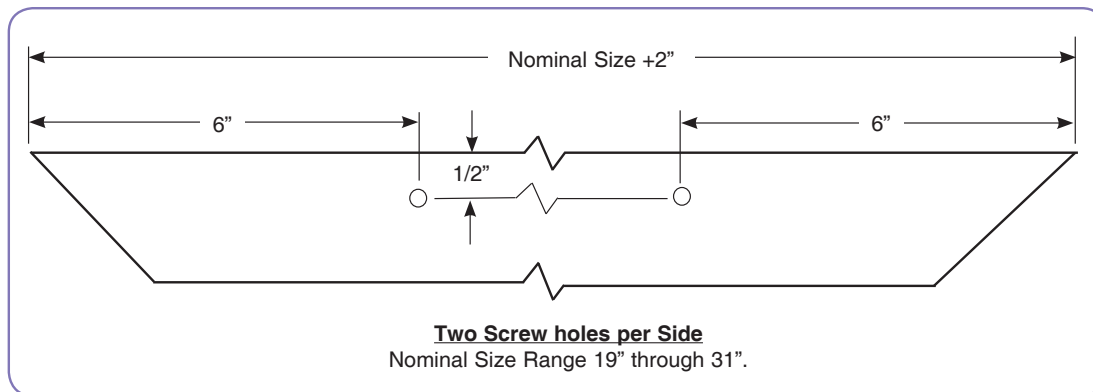
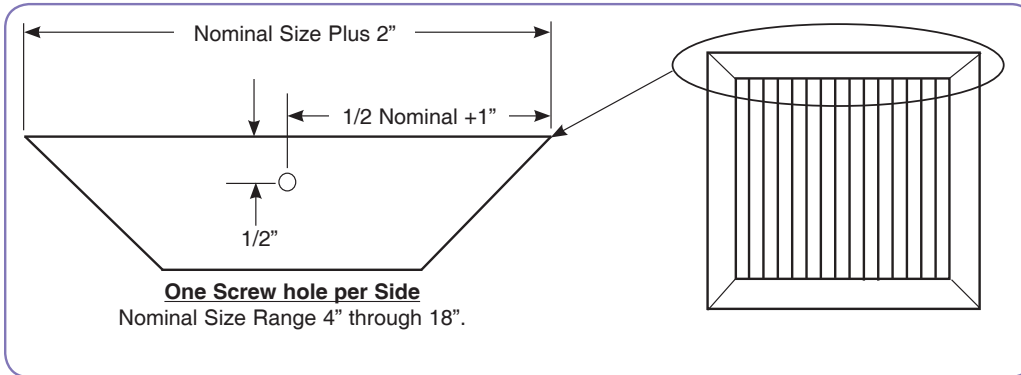

Sq. & Rect. Registers & Grilles