



Application

45° return filter grilles are used as return units that match the appearance of the supply outlets. They are well suited for locations where the occupant can see into the duct, and can be mounted on the wall or in the ceiling.

Standard Features

- Steel construction.
- Teardrop blades are 3/4" deep, on 2/3" centers.
- Deflection is fixed at 45°.
- Minimum grille size is 4" x 4".
- Choice of 1" or 2" deep filter.
- Grille is attached to frame via full-length piano hinge.
- Grille is closed with knurled nut. (1/4 turn fastener available upon request.)
- Standard finish is electrocoat acrylic baked enamel.
- Standard color is #11 Bright White.
- Choice of hinging along long or short side.
- Gasket around the edge of the mounting frame.

Optional Features

- Available without filter clips (Opt. H or J).

Sizing and Performance Notes

- Performance data in this catalog does not include the presence of a filter.
- All grilles take the same filter size as grille nominal size, except as follows:

Nom. Size	To Fit	Takes this filter size
21" x 21"	24" x 24" T-bar	20" x 20"
21" x 45"	24" x 48" T-bar	20" x 20" (2 qty)

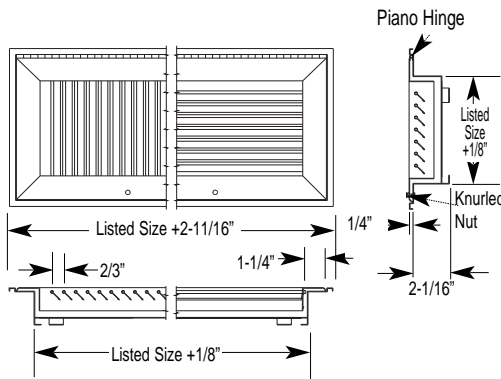

Quick Select Chart

This shows grilles with:
 • A maximum NC of 35.
 • A minimum duct velocity of 200 FPM.

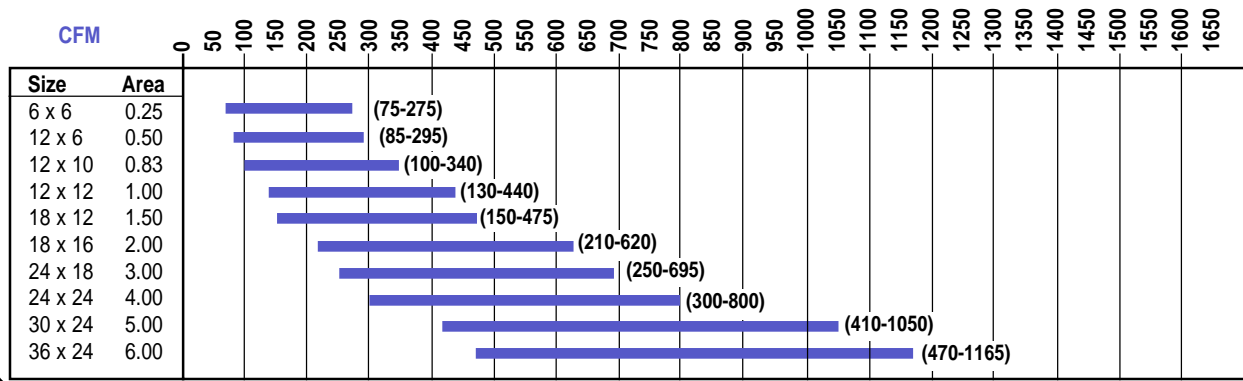

Model Numbering System

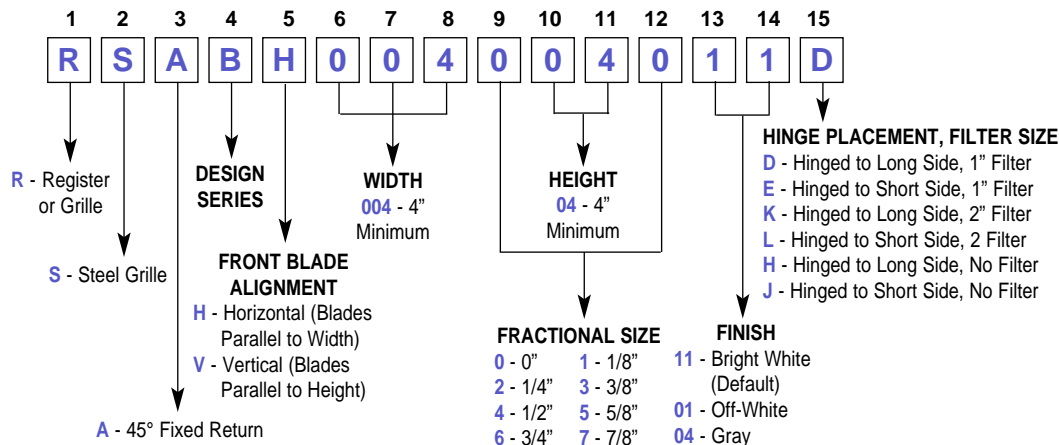

Multi-Panel Construction for the following Registers & Grilles

	Steel	Stainless Steel	Aluminum
Single Deflection	RSSB, RTSB	RLSB, RMSB, RKSB	RASM, RNSM
Double Deflection	RSDB, RTDB	RLDB, RMDB, RKDB	RADM, RNDM
0° Fixed Return	RSRB, RTRB	RLRB, RMRB, RKRB	RARM, RNRM
45° Fixed Return	RSAB, RTAB	RLAB, RMAB, RKAB	RAAM, RNAM

In-line Construction

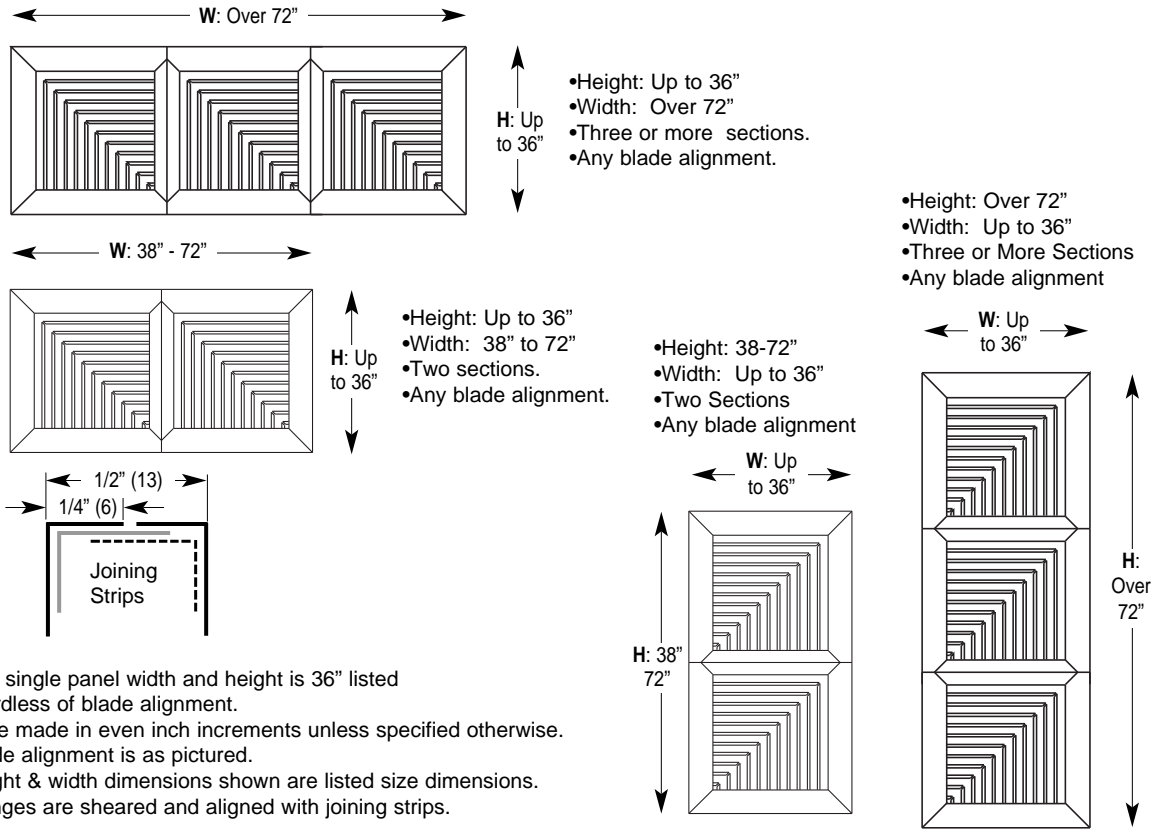

Notes:

1. Maximum single panel width and height is 36" listed size regardless of blade alignment.
2. Panels are made in even inch increments unless specified otherwise.
3. Front blade alignment is as pictured.
4. Grille height & width dimensions shown are listed size dimensions.
5. Panel flanges are sheared and aligned with joining strips.

Ganged Construction

Notes:

1. Maximum single panel width is 36" listed size.
2. Maximum single panel height is 36" listed size.
3. Panels will be made in even inch increments unless specified otherwise.
4. Front blade alignment is always parallel to center support.
5. Either the vertical or horizontal joint can be sheared down, but not both.
6. The center support can be aligned vertically or horizontally, depending on blade alignment desired. It is shown here mounted horizontally.
7. Grille height and width dimensions shown are listed size dimensions.
8. Metric dimensions are shown in millimeters.

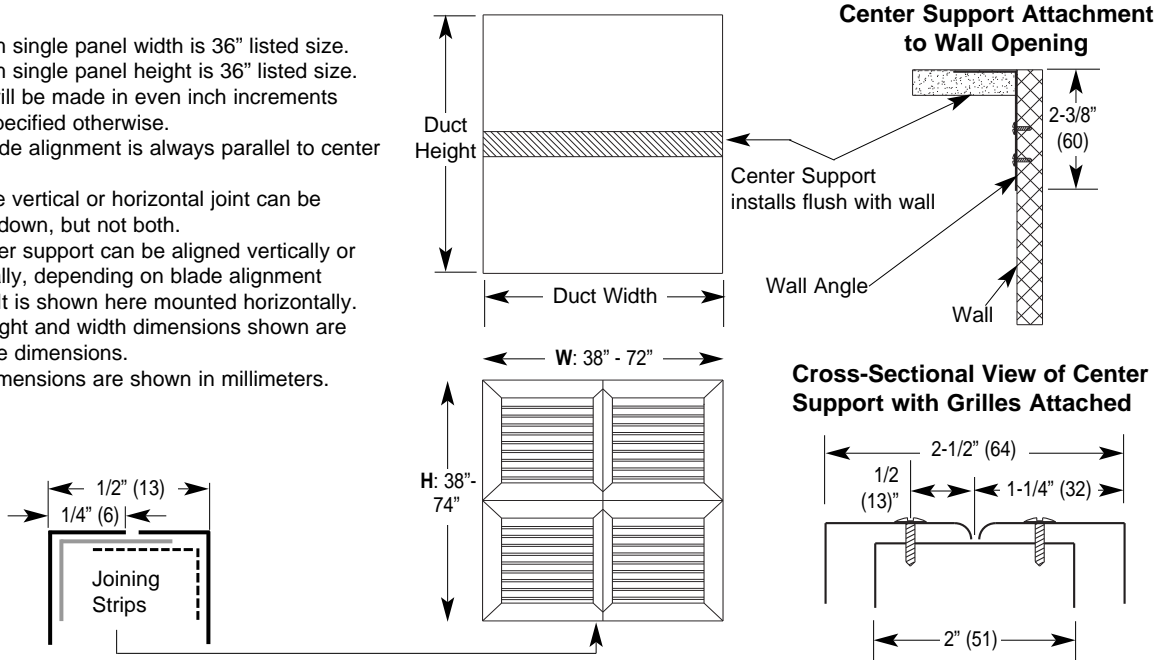

Multi-Panel Construction for the following Registers & Grilles

Steel
 Louvered Return RSLA, RTLA
 Perforated Return RSFA, RTFA

In-Line Construction

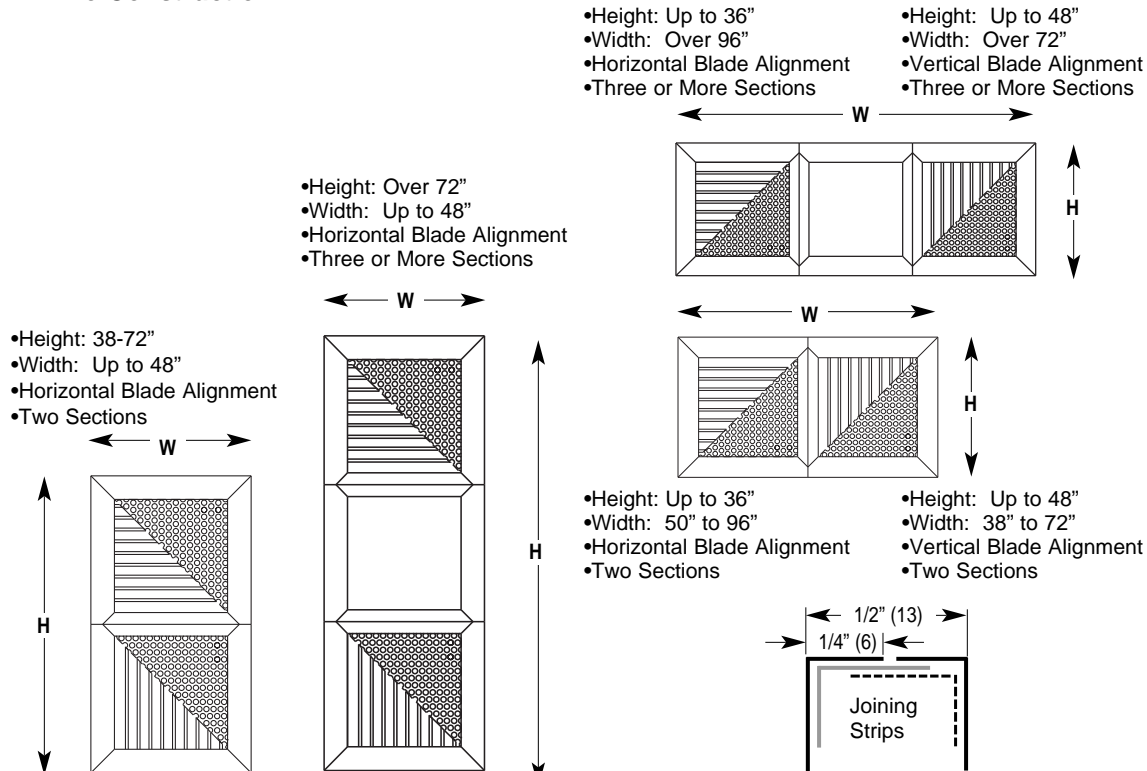

Notes:

1. Panels will be made in even inch increments unless specified otherwise.
2. Dimensions shown are listed size dimensions.
3. Max. blade length on louvered face models is nominal 48".
4. Panels are sheared and aligned with joining strips.

Ganged Construction

Notes:

1. Either the vertical or horizontal joint can be sheared down, but not both.
2. Maximum single panel width is 48" listed size.
3. Maximum blade length on louvered face models is listed size 48".
4. Maximum single panel height is 36" listed size.
5. Panels are made in even inch increments unless specified otherwise.
6. Blade alignment is always parallel to center support.
7. The center support can be aligned vertically or horizontally, depending on the blade alignment desired. It is shown here mounted horizontally.
8. Grille dimensions shown are listed size dimensions.

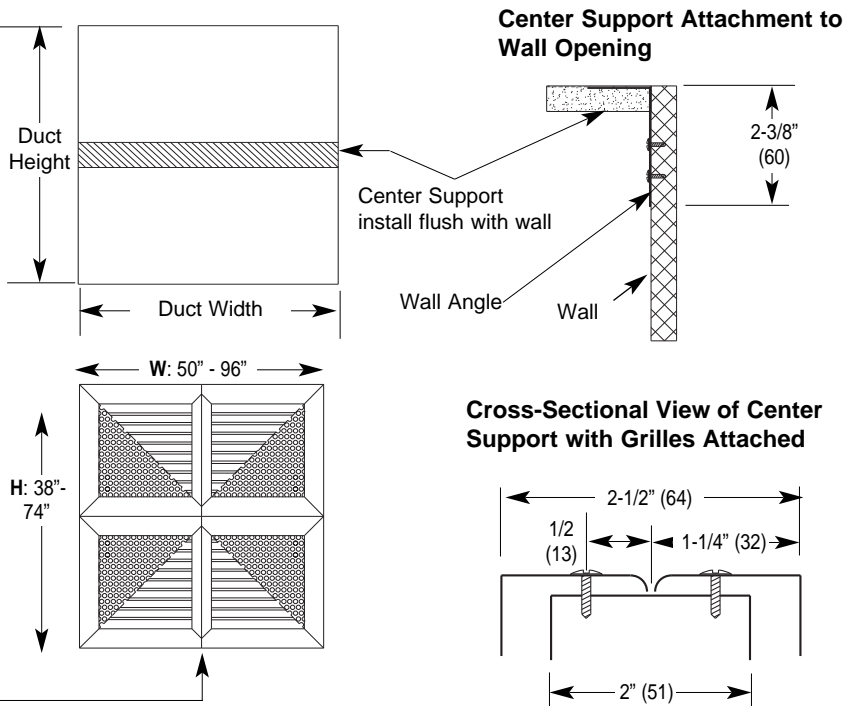
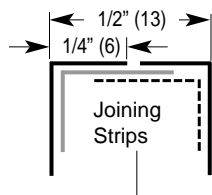

Multi-Panel In-Line Construction

Notes:

1. Maximum single panel width and height is 48" nominal size, regardless of blade alignment.
2. Panels are made in even inch increments unless specified otherwise.
3. Front blade alignment is as pictured.
4. Grille dimensions shown are nominal dimensions.
5. Panel flanges are sheared and aligned with joining strips.

- Height: 50-96"
- Width: Up to 48"
- Two Sections
- Any Blade Alignment

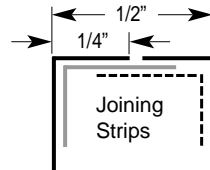
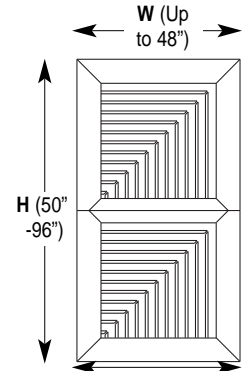

- Height: Over 96"
- Width: Up to 48"
- Three or more Sections
- Any Blade Alignment

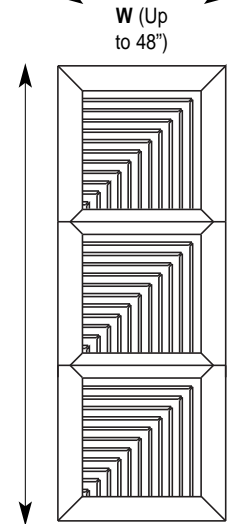

- Height: Up to 48"
- Width: 50" - 96"
- (Two Sections)
- Any Blade Alignment

- Height: Up to 48"
- Width: Over 96"
- Three or more Sections
- Any Blade Alignment

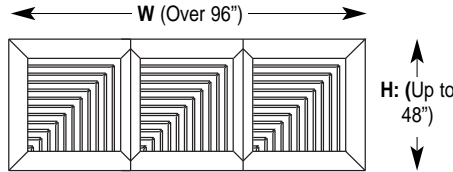
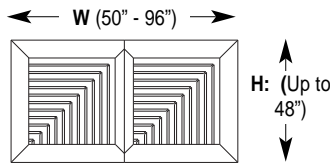

Multi-Panel Ganged Construction

Notes:

1. Maximum single panel width and height are 48" nominal size.
2. Panels are made in even inch increments unless specified otherwise.
3. Front blade alignment is always parallel to center support.
4. Either the vertical or horizontal joint can be sheared down, but not both.
5. The center support can be aligned vertically or horizontally, depending on blade alignment desired.
6. Grille dimensions shown are nominal dimensions.

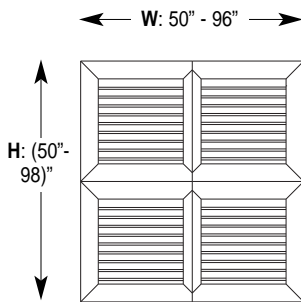

Cross-Sectional View of Center Support

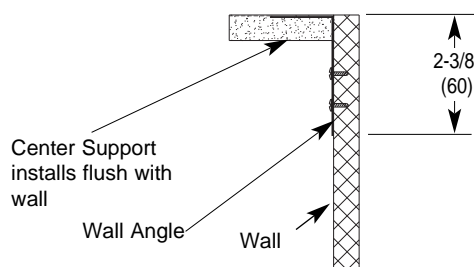
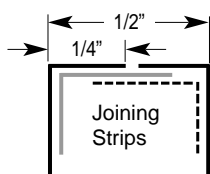
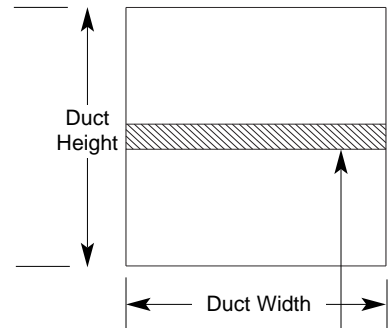
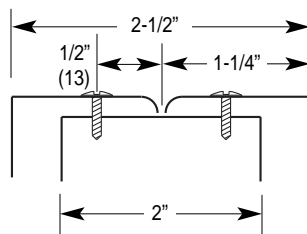

Center Support Mounted flush with wall (Shown aligned horizontally).

Sq. & Rect. Registers & Grilles

All Sections of Butted Grilles or Registers will be made in Listed Sizes as Standard.

STANDARD REGISTERS AND GRILLES

Applies to all models except louvered return air registers and grilles and door partition grilles.
Registers and grilles over 36" x 36" butting two or more grilles together.

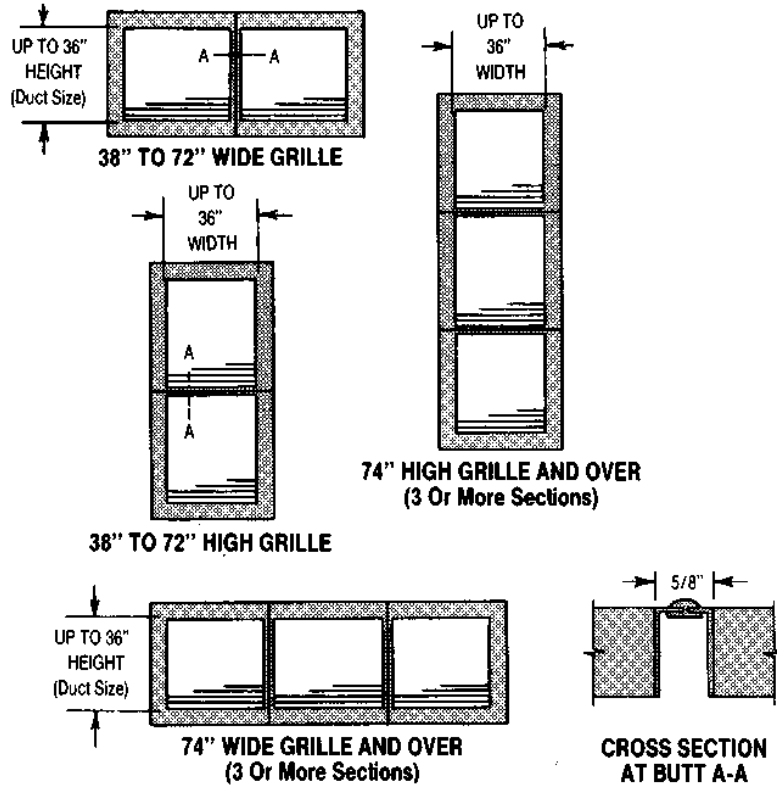

GRILLES AND REGISTERS HAVING FOUR SECTIONS AND OVER

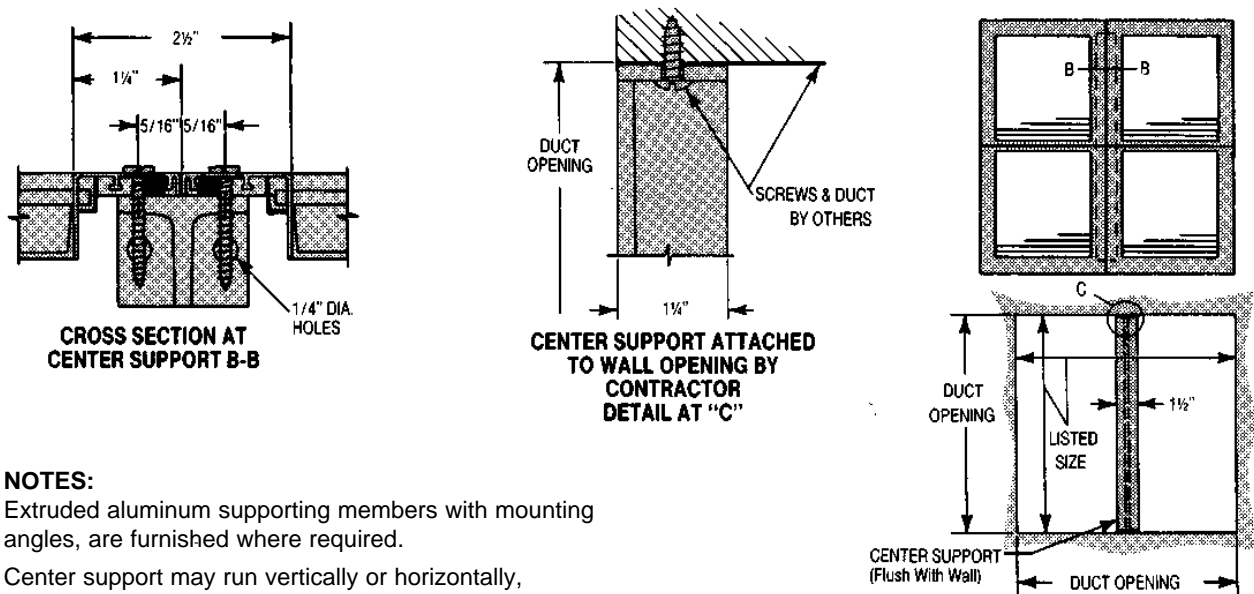

NOTES:

Extruded aluminum supporting members with mounting angles, are furnished where required.

Center support may run vertically or horizontally, depending upon combination of grilles used.

Combination of panels will be furnished to fit duct opening with satisfactory clearance.

Screw Hole Location for the following Registers & Grilles

	<u>Steel</u>	<u>Aluminum</u>	<u>Stainless Steel</u>
Single Deflection	RSSB, RTSB	RASM, RNSM	RLSB, RMSB, RKSB
Double Deflection	RSDB, RTDB	RADM, RNDM	RLDB, RMDB, RKDB
0° Fixed Return	RSRB, RTRB	RARM, RNRM	RLRB, RMRB, RKRB
45° Fixed Return	RSAB, RTAB	RAAM, RNAM	RLAB, RMAB, RKAB
Louvered Return	RSLA, RTLA	-----	-----
Perforated Return	RSFA, RTFA	RAFM, RNFM	-----

Notes:

- Screw holes on the face are standard on Registers and Grilles.
- Steel R&G can be ordered without screw holes, for use with concealed hangers (Opt. N).
- The screw holes is 5/32" in diameter.
- Each Register or Grille is provided with the appropriate number of screws as standard.
- The standard screw is #8 x 1-1/4" pan head screw, with a flat blade head.
- Tamper-proof screws are available as an option (Opt. B).

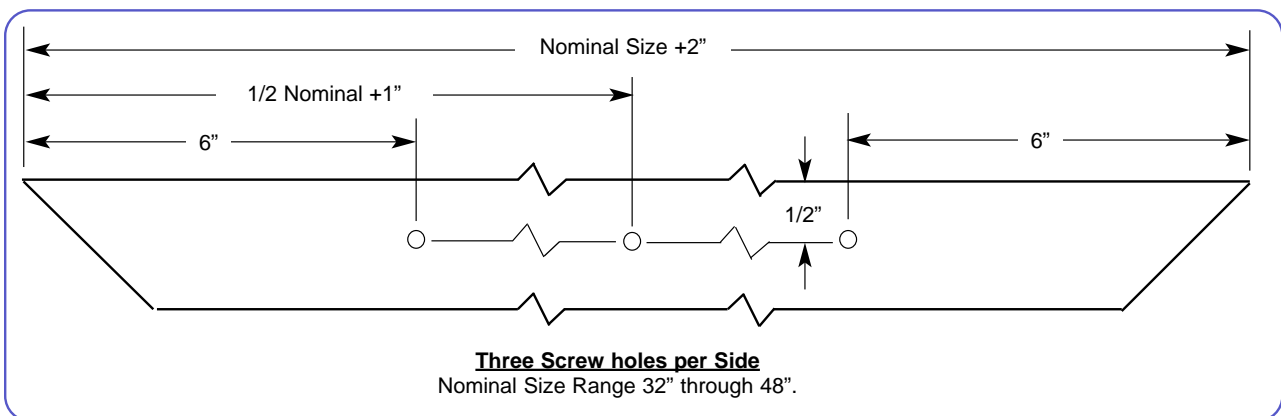
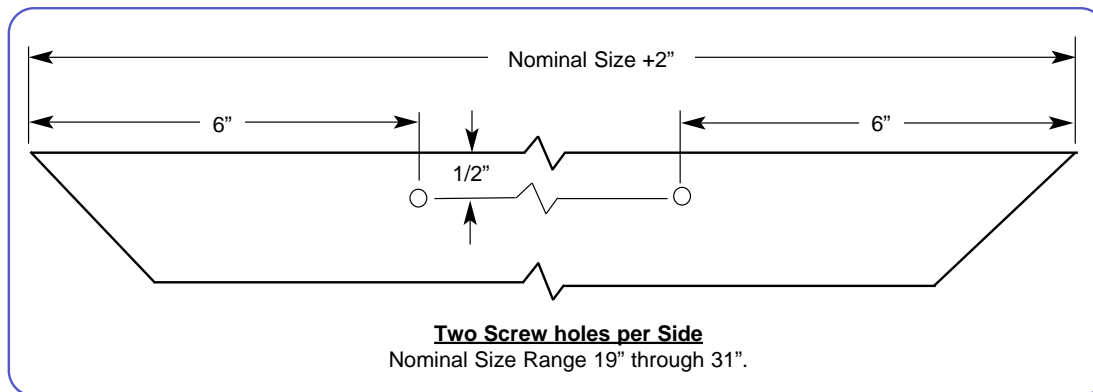
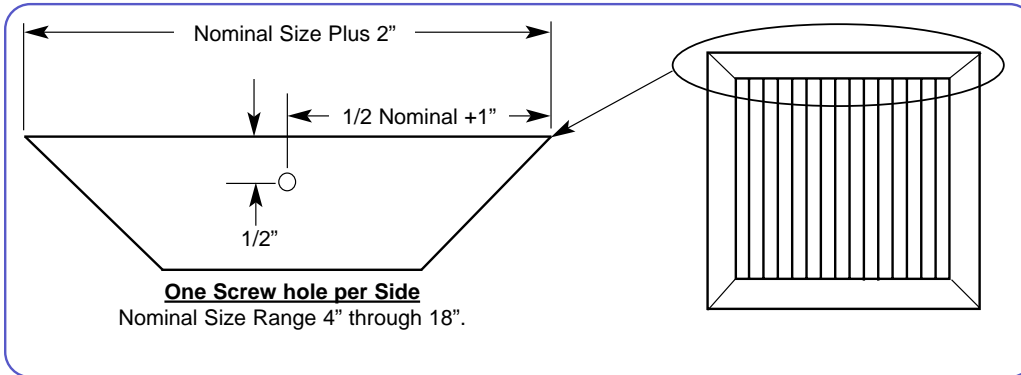

Sq. & Rect. Registers & Grilles